

Data Sheet



Article number: 604133034040

Description: Taper bored timing belt pulley
HTD 34 14M 40 TL 2517

Measures

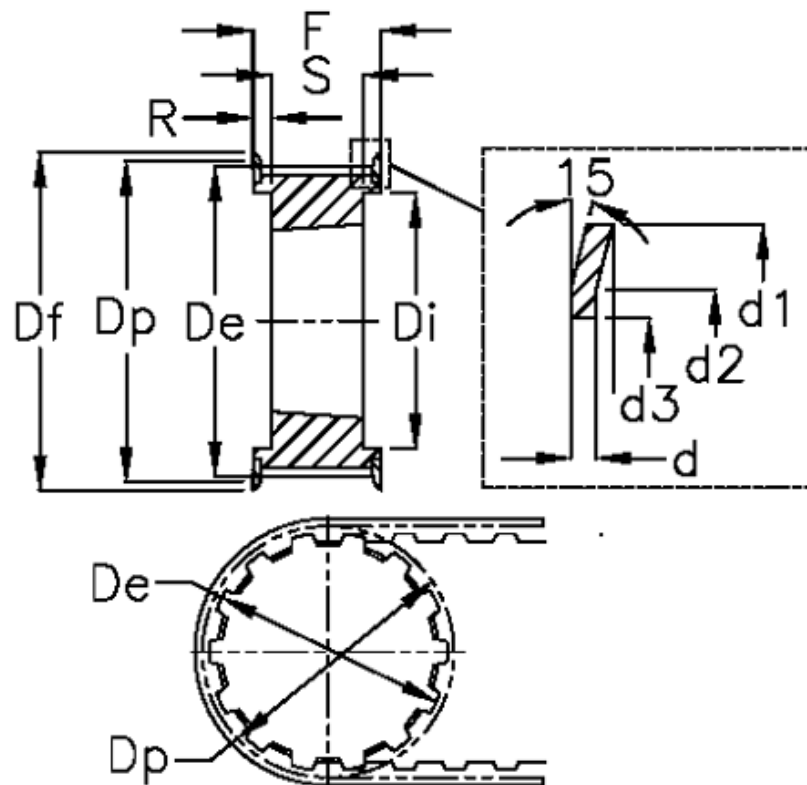

d = 2.5	F = 54	Weight = 3.87
d1 = 160	Flange type = F51	Width = 40
d2 = 148	For bushing = 2517	
d3 = 120	Max bore = 60	
De = 148.79	r = 4.5	
Df = 160	S = 45	
Di = 110	Tooth number = 34	
Dp = 151.52	Type = 14M	